

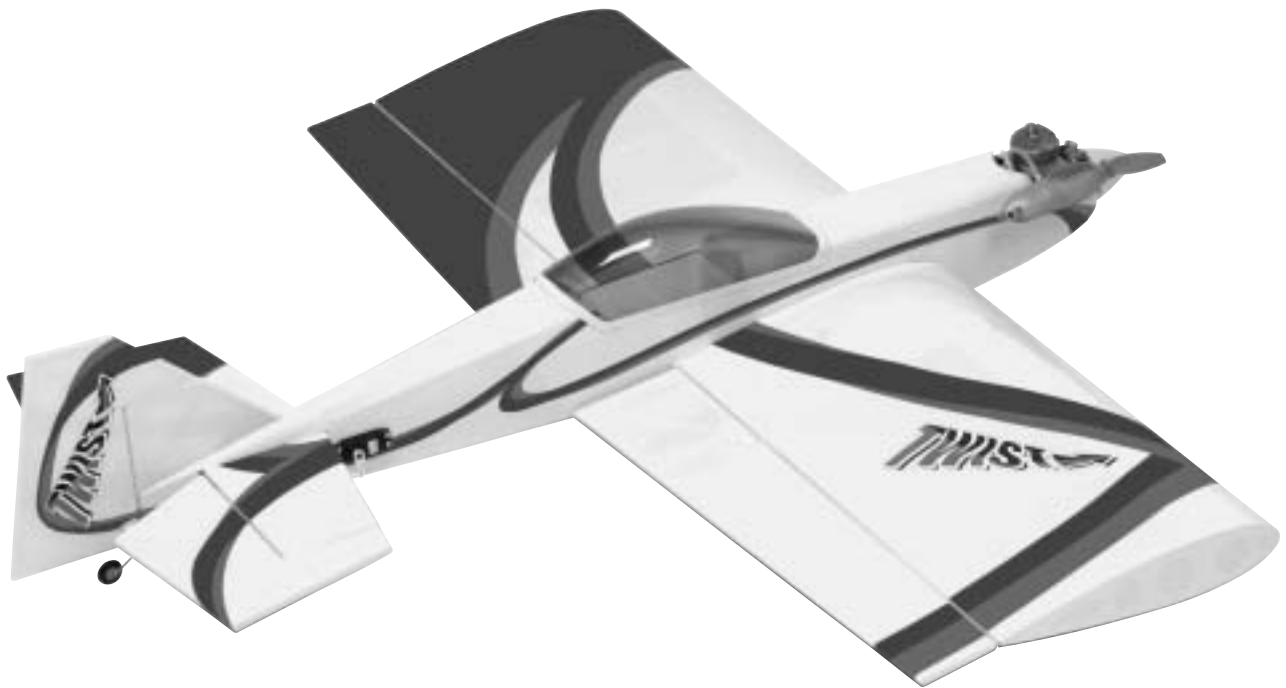

Twist™ 3D .40 ARF

ASSEMBLY MANUAL



- Great sport 3D performer
- Covered in genuine UltraCote®

Specifications

Wingspan:47.75 in (1212.85mm)

Length:48.38 in (1228.73mm)

Wing Area:747.37 sq in (48.2 sq dm)

Weight:5.0–6.0 lb (2.27 kg–2.72 kg)

Engines:40–.46 2-stroke

.56–.72 4-stroke

Radio:4-channel w/5 servos

Table of Contents

| | |
|---|----|
| Covering Colors | 2 |
| Table of Contents | 2 |
| Contents of Kit | 3 |
| Required Radio and Engine | 3 |
| Field Equipment Required | 4 |
| Additional Required Tools and Adhesives | 4 |
| Warning | 4 |
| Before Starting Assembly | 5 |
| Using the Manual | 5 |
| Warranty Information | 5 |
| Section 1: Attaching the Wing to the Fuselage | 6 |
| Section 2: Installing the Horizontal Stabilizer | 7 |
| Section 3: Installing the Vertical Stabilizer | 9 |
| Section 4: Installing the Ailerons | 11 |
| Section 5: Installing the Elevators | 13 |
| Section 6: Installing the Tail Wheel | 15 |
| Section 7: Installing the Rudder | 17 |
| Section 8A: Engine Installation | 18 |
| Section 8B: Electric Motor Installation | 19 |
| Section 9: Throttle Pushrod Installation | 21 |
| Section 10: Fuel Tank Assembly | 22 |
| Section 11: Fuel Tank Installation | 25 |
| Section 12: Landing Gear Installation | 26 |
| Section 13: Radio Installation | 27 |
| Section 14: Linkage Installation | 30 |
| Section 15: Canopy Installation | 34 |
| Adjusting the Engine | 36 |
| Control Throws | 36 |
| Recommended CG | 36 |
| Preflight | 37 |
| Range Testing the Radio | 37 |
| 2004 Official AMA National Model Aircraft Safety Code | 38 |

Covering Colors

- | | | | |
|-----------------|---------|----------------|---------|
| • Bright Yellow | HANU872 | • Smoke Purple | HANU868 |
| • Deep Pink | HANU867 | | |

Contents of Kit

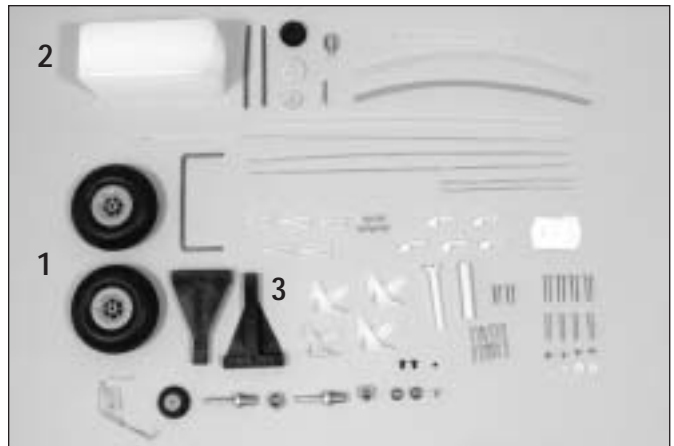
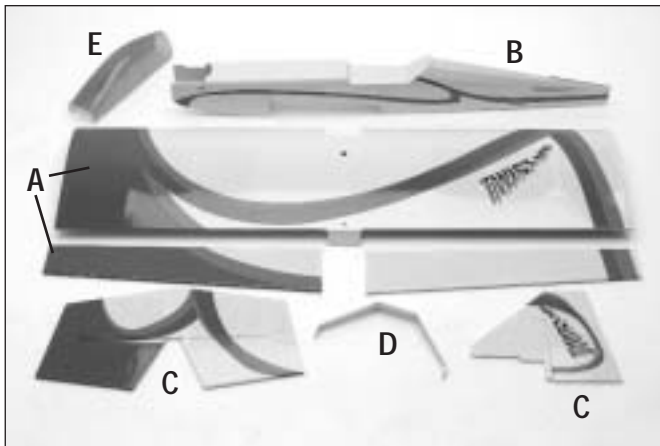

Large Parts:

| | |
|-----------------|---------|
| A. Wing Set | HAN2651 |
| B. Fuselage | HAN2652 |
| C. Tail Set | HAN2653 |
| D. Landing Gear | HAN2654 |
| E. Canopy | HAN2656 |

Small Parts:

| | |
|---|---------|
| 1. 2 ³ / ₄ " Wheels | HAN305 |
| 2. Fuel Tank | HAN1986 |
| 3. Engine Mount | HAN1985 |

Items Not Shown:

| | |
|-----------|---------|
| Decal Set | HAN2655 |
|-----------|---------|

Required Radio and Engine

Radio Equipment

- 4-channel radio system (minimum)
- 5 standard servos (JRPS537 recommended or equivalent)
- 12" Servo Extension (JRPA098) (2)
- Large Servo Arm (JRPA212) (2)
- "Y" Harness (JRPA135) or
- 3" Servo Extension (JRPA093) (2)
- Radio Switch (JRPA003)

Recommended Engines

- .40-.46 2-stroke
- .56-.72 4-stroke



**Evolution .46NT
EVOE0460**

Recommended JR® Systems

- XF421EX
- XF631
- XP662
- X-378
- XP8103
- 10X



JR XF631



**Saito .72 AAC
SAIE072**



JR XP8103

Field Equipment Required

- Propeller (MAS1060)
- Fuel
- Glow Plug Wrench (HAN2510)
- Glow Plug Igniter with Charger (HAN7101)
- Glow Plug (HAN3001/3006)
- Manual Fuel Pump (HAN118)

Additional Required Tools and Adhesives

Tools

- Canopy scissors
- Drill
- Drill bits: 1/16", 3/32", 1/8", 9/64", 5/32"
- Felt-tipped pen
- Flat blade screwdriver
- Foam: 1/2"
- Hobby knife
- Masking tape
- Paper towels
- Petroleum jelly
- Phillips screwdriver (large)
- Phillips screwdriver (small)
- Pliers
- Rubbing alcohol
- Ruler
- Sandpaper
- Soldering iron
- Square
- T-Pins

Adhesives

- 6-Minute Epoxy (HAN8000)
- 30-Minute Epoxy (HAN8002)
- Thin CA (PAAPT07)
- Medium CA (PAAPT01)
- CA Remover/Debonder (PAAPT16)
- Masking Tape (MMM20901)
- CA Remover/Debonder (PAAPT16)
- Canopy glue (Formula 560)

Other Required Items

- 2 1/4" spinner (yellow)
- Epoxy Brushes (DUB345)
- File
- Measuring device (e.g. ruler, tape measure)
- Mixing Sticks for Epoxy (DUB346)
- Paper towels
- Rubbing alcohol
- Wax paper

Warning

An RC aircraft is not a toy! If misused, it can cause serious bodily harm and damage to property. Fly only in open areas, preferably at AMA (Academy of Model Aeronautics) approved flying sites, following all instructions included with your radio and engine.

Before Starting Assembly

Before beginning the assembly of your Twist™, remove each part from its bag for inspection. Closely inspect the fuselage, wing panels, rudder, and stabilizer for damage. If you find any damaged or missing parts, contact the place of purchase.

If you find any wrinkles in the covering, use a heat gun or covering iron to remove them. Use caution while working around areas where the colors overlap to prevent separating the colors.



HAN100 – Heat Gun



HAN101 – Covering Iron

Using the Manual

This manual is divided into sections to help make assembly easier to understand and to provide breaks between each major section. In addition, check boxes have been placed next to each step to keep track of each step completed. Steps with two boxes indicate that the step will require repeating, such as for a right or left wing panel, two servos, etc. Remember to take your time and follow the directions.

Warranty Information

Horizon Hobby, Inc. guarantees this kit to be free from defects in both material and workmanship at the date of purchase. This warranty does not cover any parts damage by use or modification. In no case shall Horizon Hobby's liability exceed the original cost of the purchased kit. Further, Horizon Hobby reserves the right to change or modify this warranty without notice.

In that Horizon Hobby has no control over the final assembly or material used for the final assembly, no liability shall be assumed nor accepted for any damage of the final user-assembled product. By the act of using the product, the user accepts all resulting liability.

Once assembly of the model has been started, you must contact Horizon Hobby, Inc. directly regarding any warranty question that you have. Please do not contact your local hobby shop regarding warranty issues, even if that is where you purchased it. This will enable Horizon to better answer your questions and service you in the event that you may need any assistance.

If the buyer is not prepared to accept the liability associated with the use of this product, the buyer is advised to return this kit immediately in new and unused condition to the place of purchase.

Horizon Hobby
4105 Fieldstone Road
Champaign, Illinois 61822
(877) 504-0233
www.horizonhobby.com

Section 1: Attaching the Wing to the Fuselage

Required Parts

- Wing
- Fuselage
- 1/4" x 1 3/4" wing dowel
- 1/4-20 x 2" nylon bolt

Required Tools and Adhesives

- 6-minute epoxy
- Sandpaper
- Flat blade screwdriver

Step 1

Locate the 1/4" x 1 3/4" wing dowel. Sand a small taper on one end of the dowel to make it easier to attach the wing to the fuselage.



Step 2

Glue the dowel into the wing using 6-minute epoxy. Make sure there is about 1/2" of the dowel exposed.

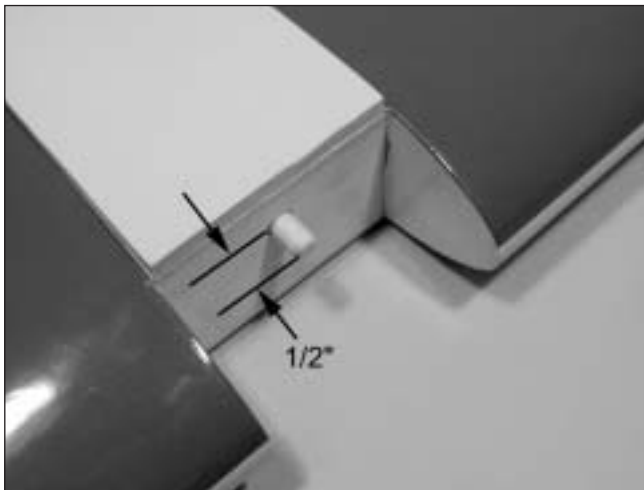

Step 3

Place the wing onto the fuselage. Secure the wing using the 1/4-20 x 2" nylon bolt.

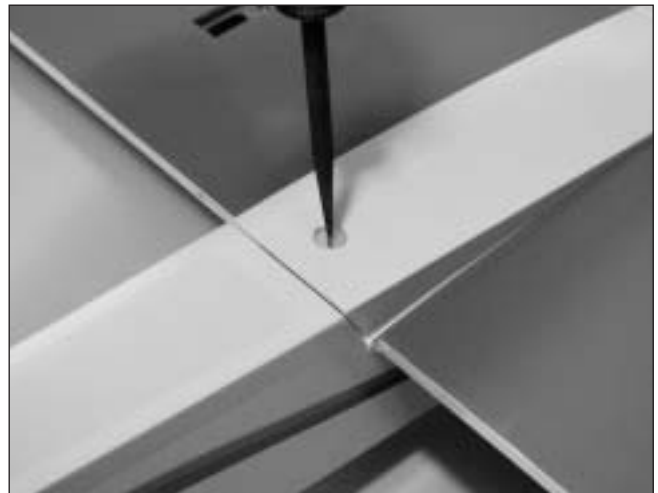

Section 2: Installing the Horizontal Stabilizer

Required Parts

- Wing
- Fuselage
- Horizontal stabilizer
- Elevator joiner wire

Required Tools and Adhesives

- Flat blade screwdriver
- Sandpaper
- Felt-tipped pen
- Paper towel
- Rubbing alcohol

Step 1

Slide the stab into the slot in the fuselage, with the leading edge pushed forward in the slot. Center the stab in the opening by measuring the distance from the fuselage to each tip. The stab is aligned when both measurements are identical.

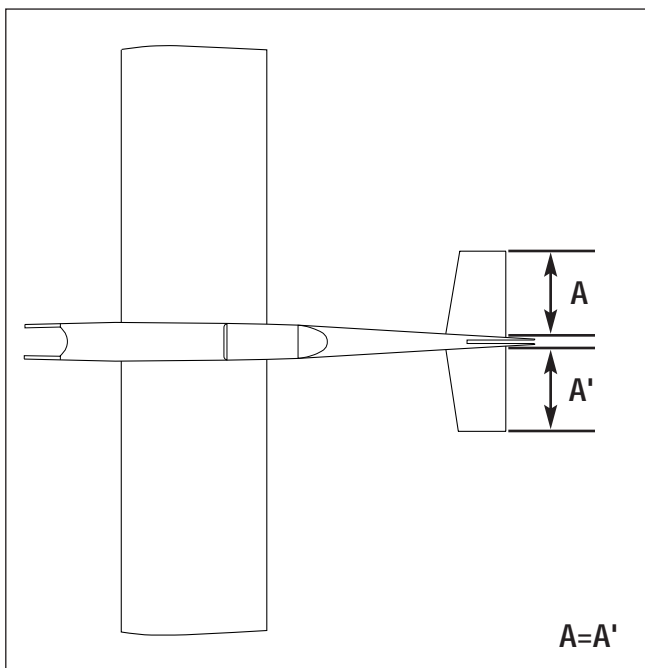

Step 2

Check the distance from each stab tip to each wing tip. These measurements must also be equal.

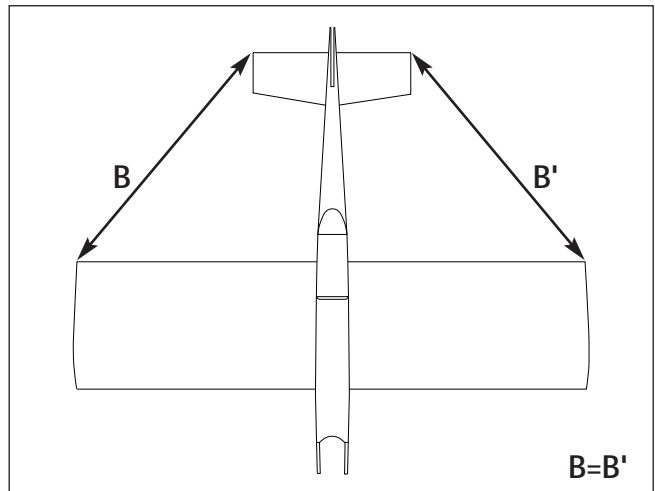

Step 3

The last alignment step is making sure the wing and stabilizer are parallel. If they are not, lightly sand the opening in the fuselage for the stab until the stab rests parallel to the wing.

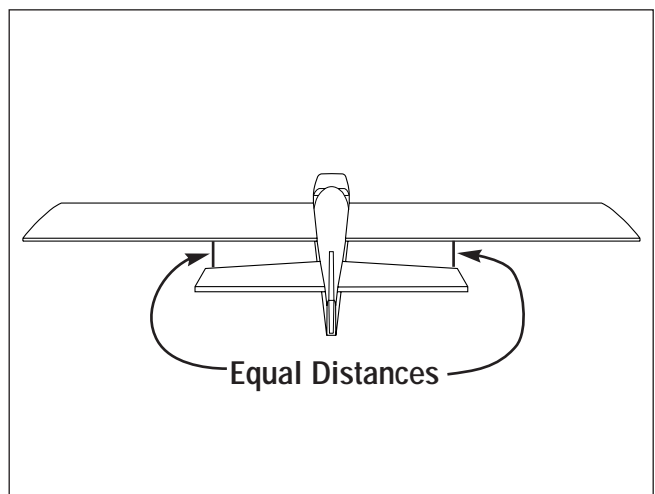

Section 2: Installing the Horizontal Stabilizer

Step 4

Use a felt-tipped pen to trace the outline of the fuselage on the top and bottom of the stab.

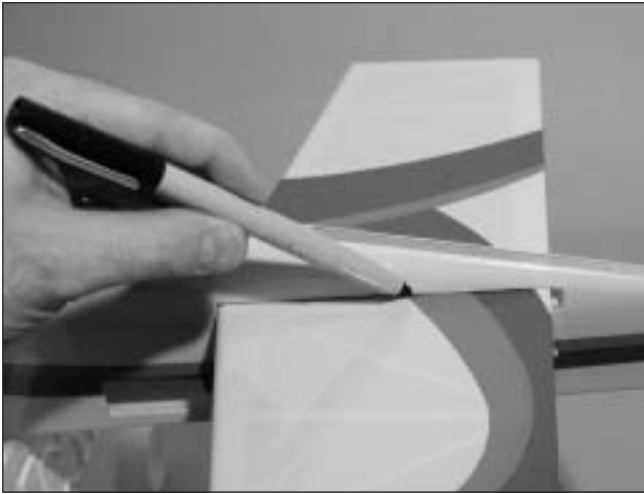

Step 5

Remove the stab and use a hobby knife with a brand new blade to remove the covering 1/16" inside the lines just drawn.

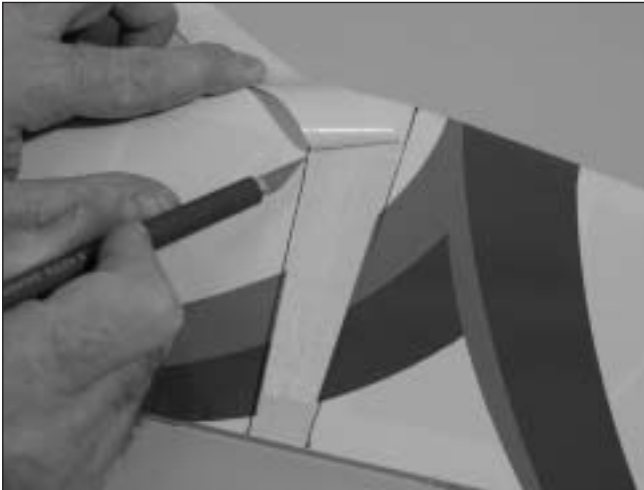

Note: DO NOT cut into the underlying wood. Let the knife "float" across the covering. Cutting into the wood will weaken the stabilizer and may cause it to fail in flight.

Hint: You can use a soldering iron instead of a hobby knife to remove the covering. Doing so will eliminate accidentally cutting into the stabilizer.

Step 6

Place the elevator joiner wire into the slot for the stab. Reposition the stab into the fuselage. It may be necessary to trim the opening at the rear to allow for clearance for the joiner wire.



Hint: Use a little rubbing alcohol and a paper towel to remove the felt-tipped marker lines once they are no longer needed.

Section 2: Installing the Horizontal Stabilizer

Step 7

Slide the stabilizer from the fuselage far enough to expose the uncovered area. Mix 1/2 ounce of 30-minute epoxy. Apply the epoxy to the exposed area on both the top and bottom of the stab. Slide the stab back into position and double-check the alignment of the stab. Remove any excess epoxy using a paper towel and rubbing alcohol.



Photo for Step 7



Hint: Use a little masking tape to keep the joiner wire out of the way until it's time to install the elevators. Also make sure there is no epoxy on the joiner wire.

Section 3: Installing the Vertical Stabilizer

Required Parts

- Wing
- Fuselage
- Vertical stabilizer

Required Tools and Adhesives

- 30-minute epoxy
- Sandpaper
- Square
- Ruler
- Felt-tipped pen

Step 1

Locate the vertical stabilizer (fin) and slide it into position. Position the fin so it is fully forward in the slot in the fuselage.

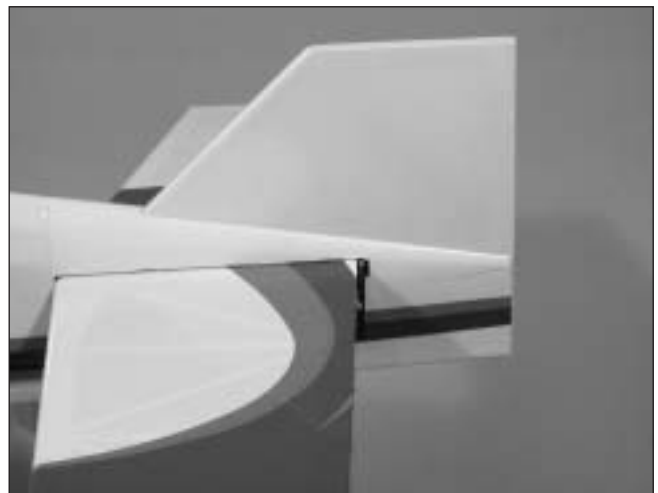

Section 3: Installing the Vertical Stabilizer

Step 2

Check the alignment between the fin and stab. The fin must be 90-degrees to the stab to be in alignment. Sand the opening in the fuselage if necessary to get the perfect alignment.



Step 3

Trace the outline of the fuselage onto the fin.

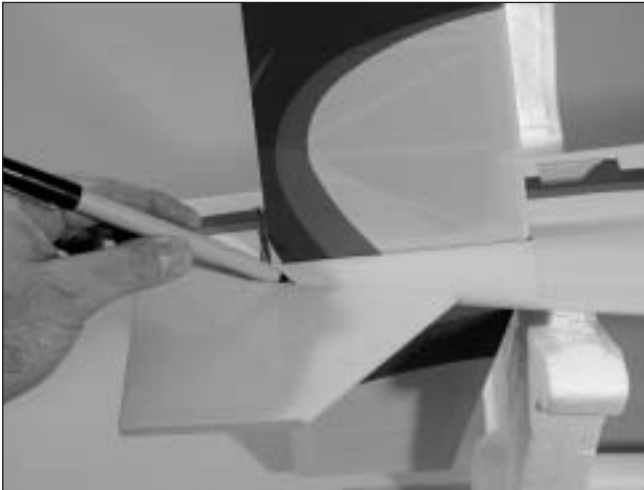

Step 4

Remove the covering 1/16" below the line drawn in the last step.

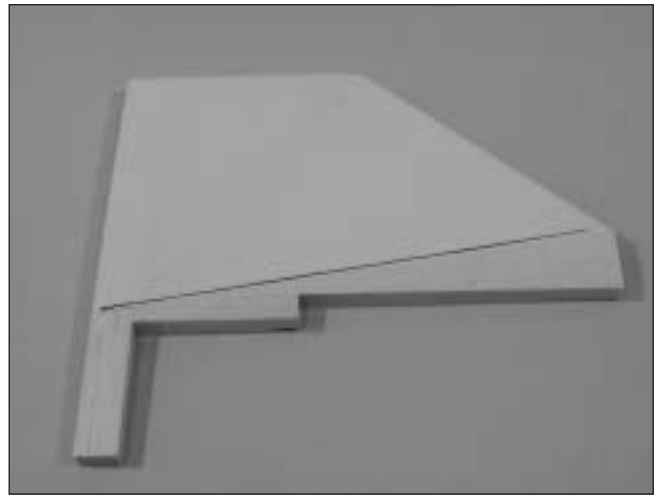

Step 5

Mix 1/2 ounce of 30-minute epoxy. Apply the epoxy to the tab on the fin and to the area on the top of the fuselage where the covering was removed. Position the fin in the slot and check the alignment. Use masking tape to hold the fin in position until the epoxy fully cures.

Hint: Use rubbing alcohol and a paper towel to clean up any excess epoxy.

Section 4: Installing the Ailerons

Required Parts

- Wing
- CA hinge (8)
- Aileron (left and right)

Required Tools and Adhesives

- Thin CA
- T-Pins

Step 1

Locate 8 of the CA hinges. Place a T-pin in the center of four of the hinges.



Step 2

Place the hinges in the precut slots in the aileron (or wing if you prefer). The T-pin will rest against the edge when installed correctly.

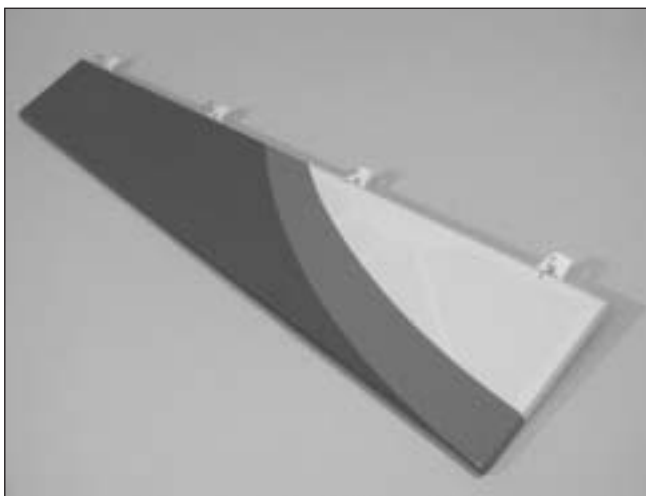

Step 3

Slide the aileron and wing together. The gap between the aileron and wing should be infinitely small, approximately 1/64".

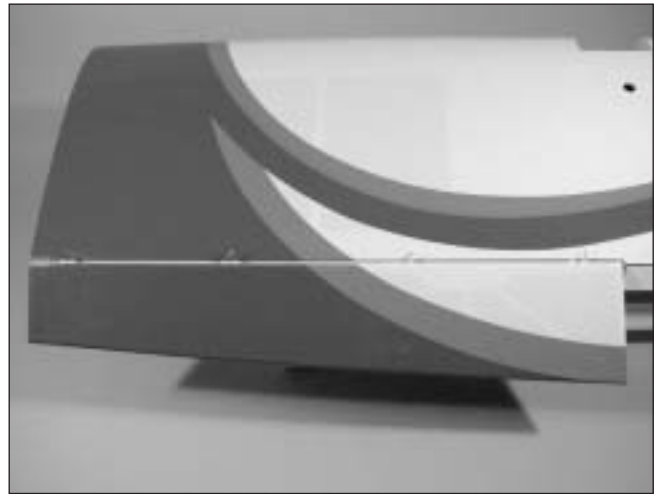

Hint: Be careful of the T-Pins, as they can be sharp.

Step 4

Use a ruler to align the end of the aileron to the wing.

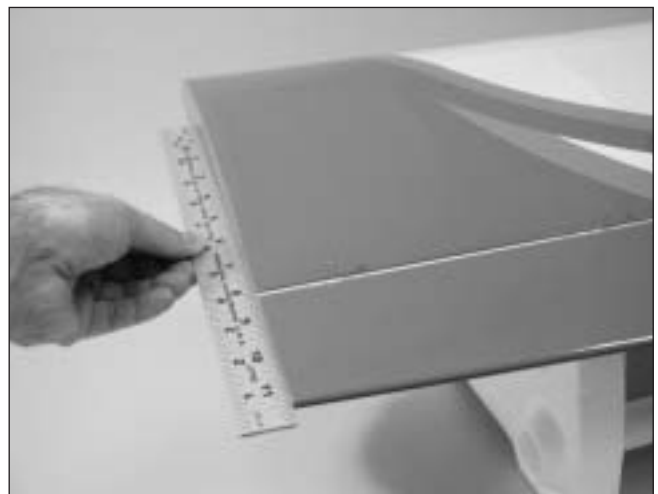

Note: Do not use CA accelerator during the hinging process. The CA must be allowed to soak into the hinge to provide the best bond. Using accelerator will not provide enough time for this process.

Section 4: Installing the Ailerons

Step 5

Remove the T-Pins and apply thin CA to each hinge. Make sure the hinge is fully saturated with CA. Use a paper towel and CA remover/debonder to clean up any excess CA from the wing and/or aileron.

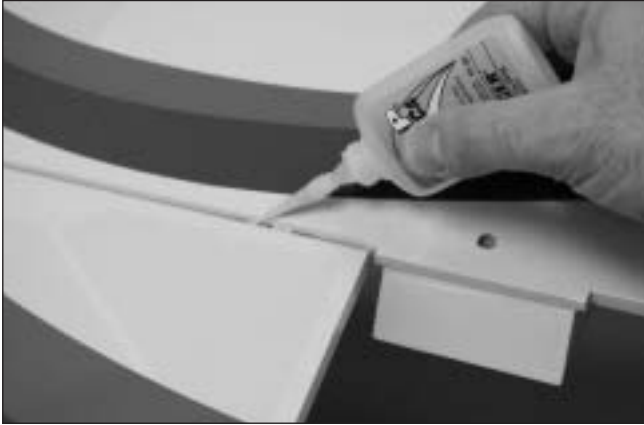

Step 6

Firmly grasp the wing and aileron and gently pull on the aileron to ensure the hinges are secure and cannot be pulled apart. Use caution when gripping the wing and aileron to avoid crushing the structure.



Step 7

Work the aileron up and down several times to work in the hinges and check for proper movement.



Step 8

Repeat Steps 1 through 7 for the remaining aileron.

Section 5: Installing the Elevators

Required Parts

- Fuselage assembly
- Elevator joiner wire
- Elevator (left and right)
- CA hinge (6)

Required Tools and Adhesives

- Thin CA
- T-Pins
- 30-minute epoxy
- Sandpaper
- Drill
- Drill bit: 9/64"
- Ruler

Step 1

Locate one of the elevator halves. Measure in $1\frac{1}{8}$ " from the inside edge of the elevator and drill a $\frac{9}{64}$ " hole in the elevator that is 1" deep for the elevator joiner wire.

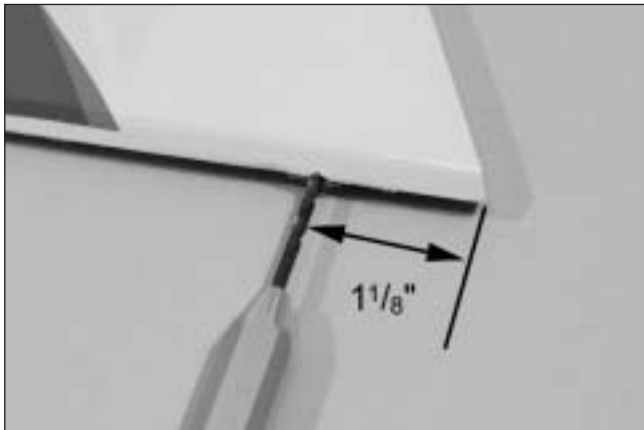

Step 2

Use a hobby knife to cut a slot from the hole drilled in the previous step to the inside edge of the elevator. This slot is where the elevator joiner wire will rest.



Step 3

Locate three CA hinges. Place a T-pin in the center of the hinges. Place the hinges into the elevator half.

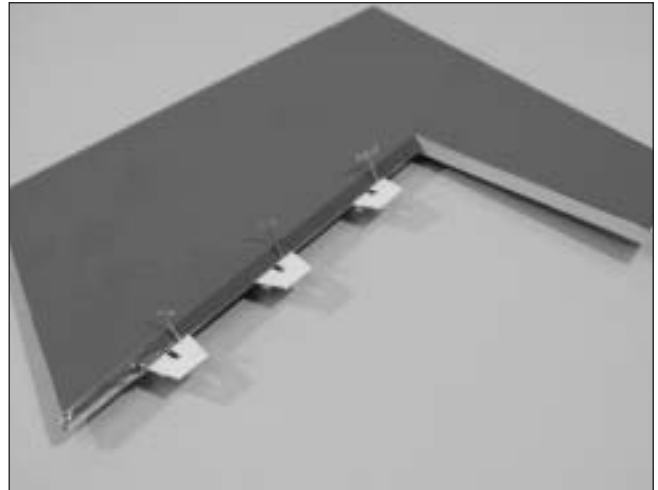

Step 4

Test fit the elevator and stab together. The elevator joiner wire will be inserted into the hole drilled in Step 1.



Step 5

Mix 1/2 ounce of 30-minute epoxy and apply it to the groove and hole in the elevator half. Insert the elevator joiner wire. Remove any excess epoxy using rubbing alcohol and a paper towel.

Section 5: Installing the Elevators

Note: You can combine the previous step with the following step if you like. This will hold the elevator in position while the epoxy cures.

□ □ Step 6

Check to make sure the elevator moves freely. It should not rub against the stabilizer at the tip. Check to make sure the hinge gap between the elevator and stabilizer is roughly 1/64". Apply thin CA to both sides of the hinge. Make sure to saturate the hinge and don't use accelerator.

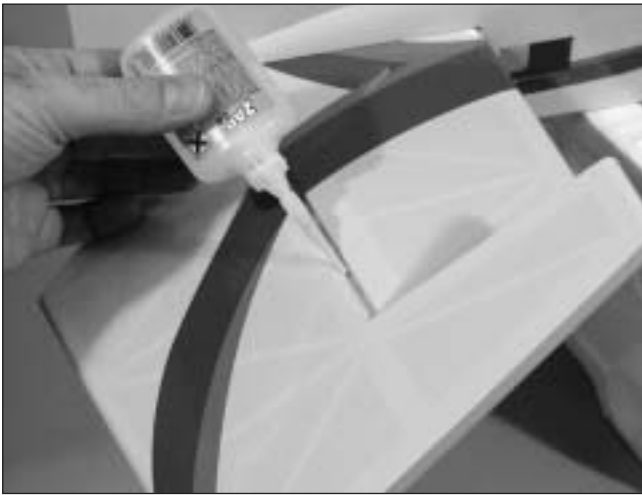

□ □ Step 7

Once the CA and epoxy have fully cured, gently pull on the elevator and stab to make sure the hinges are well glued. Flex the elevators a few times to break in the hinges.

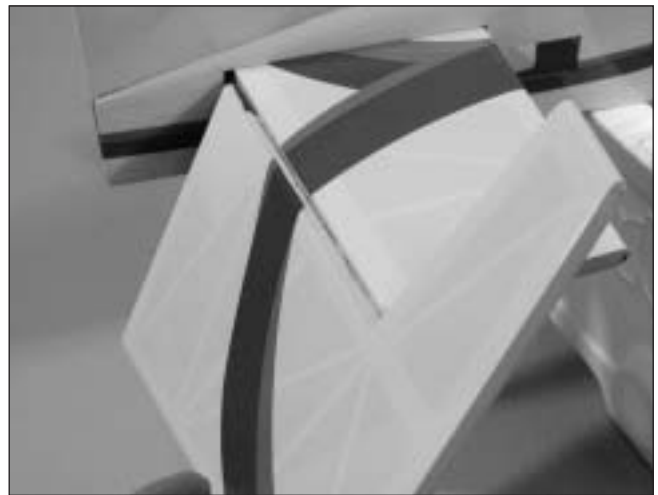
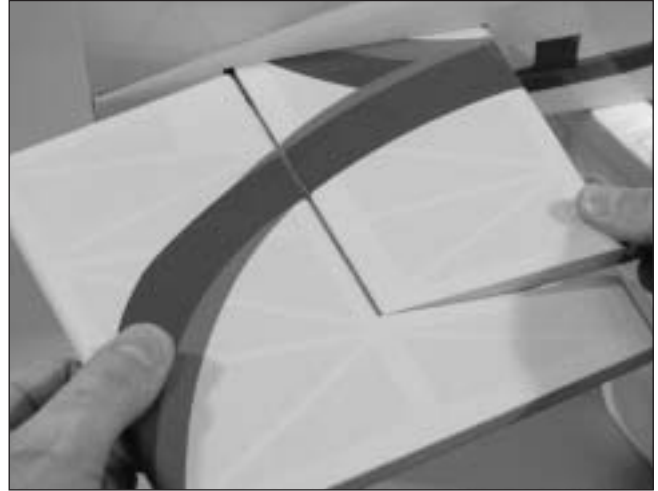

Section 5: Installing the Elevators

Step 8

Hold the remaining elevator in position against the stabilizer. Mark the location of the elevator joiner wire onto the elevator.



Step 9

Drill the location marked in the previous step using a 9/64" drill bit.



Step 10

Repeat Steps 2 through 7 to install the remaining elevator half.

Section 6: Installing the Tail Wheel

Required Parts

- Fuselage assembly
- Rudder
- Tail wheel assembly

Required Tools and Adhesives

- T-Pins
- Hobby knife
- 6-minute epoxy
- Drill
- Drill bit: 1/8"
- Paper towel
- Rubbing alcohol
- Petroleum jelly

Step 1

Locate the rudder and make a mark 1" from the bottom. Drill the location using a 1/8" drill bit. Make sure the drill is perpendicular to the hinge line of the rudder.

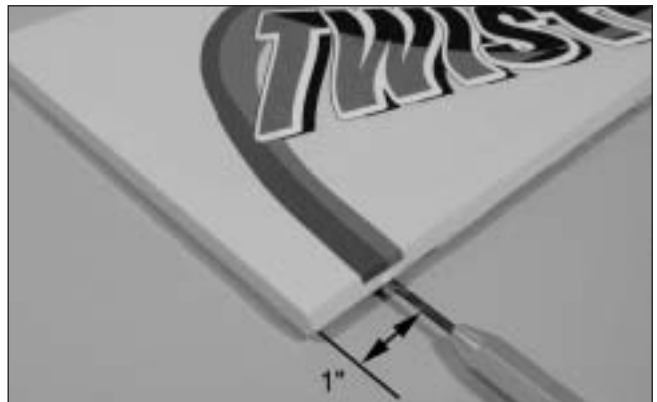

Section 6: Installing the Tail Wheel

Step 2

Cut a groove from the hole to the bottom of the rudder. This is necessary to provide clearance for the tail wheel bearing.



Step 3

Test fit the tail wheel bracket into the rudder. Make sure there is plenty of clearance for the bracket bushing and that the hole has been drilled deep enough to fit the tail wheel wire.

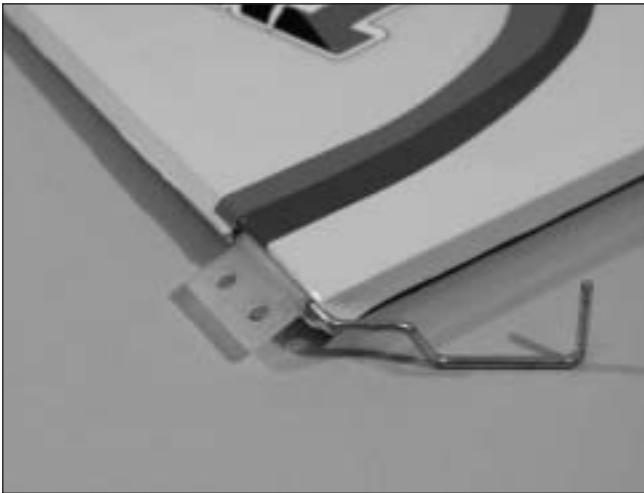

Step 4

Cut a slot in the aft end of the fuselage for the tail wheel bearing using a hinging tool or hobby knife. Position the top of the slot $7/8$ " from the bottom of the fuselage. The slot should be $13/16$ " long, which is the length of the tail wheel bearing.

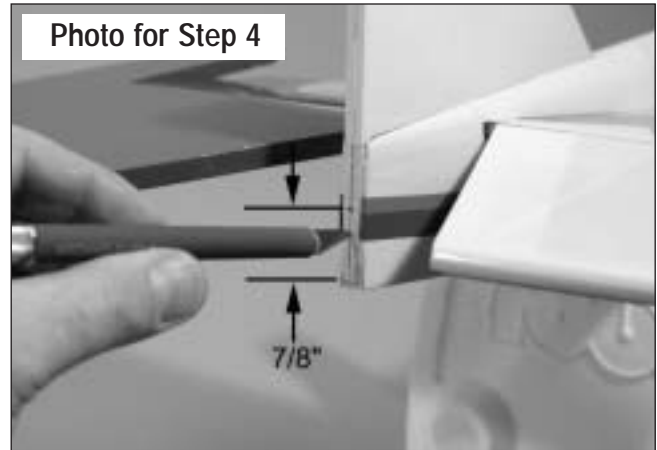

Step 5

Test fit the tail wheel bearing into the slot. Make the slot large enough that the bushing will fit without forcing the wood apart.

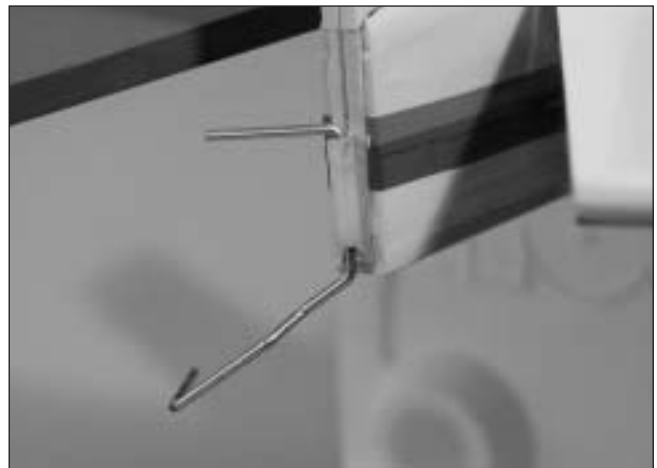

Step 6

Apply a light coat of petroleum jelly onto the tail gear wire where the bearing will ride. This is done to prevent the epoxy from sticking to the wire and bearing.

Step 7

Mix $1/2$ ounce of 6-minute epoxy and apply it to both the tail gear bearing and the slot in the fuselage. Install the bearing. Use a paper towel and rubbing alcohol to remove any excess epoxy from the tail gear wire, bushing and fuselage.

Section 7: Installing the Rudder

Required Parts

- Fuselage assembly
- Rudder
- CA hinge (3)

Required Tools and Adhesives

- Thin CA
- T-Pins
- 6-minute epoxy

Step 1

Locate the last three CA hinges, and place T-pins in the center like we have done for the ailerons and elevator.

Step 2

Install the hinges in the rudder.

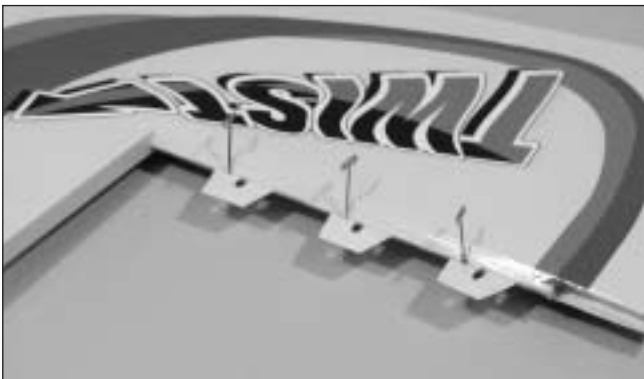

Step 3

Test fit the rudder to the fuselage. Make sure the tail gear wire goes into the rudder, and that the rudder will rest tight against the fin and fuselage. The tail gear bearing should not interfere with the rudder.



Step 4

Mix 1/2 ounce of 6-minute epoxy. Remove the rudder, and place the epoxy only in the hole, not in the groove. Epoxy in the groove will probably make it difficult to use the rudder. Install the rudder as described in the previous step.

Hint: You can combine the previous step with the following step if you like. This will hold the rudder in position while the epoxy cures.

Step 5

Check to make sure the rudder moves freely. It should not rub against the fin at the tip. Apply thin CA to both sides of the hinge. Make sure to saturate the hinge, and don't use accelerator. Use a paper towel and CA debonder/remover to clean up any excess CA.



Step 6

Once the CA and epoxy have fully cured, give the rudder and fin the tug test to make sure the hinges are well glued. Flex the rudder a few times to break in the hinges.

Section 8A: Engine Installation

Required Parts

- Fuselage assembly
- Engine mount (2)
- 8-32 x 3/4" screw (4)
- 3mm washer (4)
- 3mm x 20mm screw (4)
- 3mm lock nut (4)

Required Tools and Adhesives

- Drill
- Drill bit: 9/64"
- Engine
- Pliers
- Clamp
- Phillips screwdriver (large)

Step 1

Attach the engine mount to the firewall using four 8-32 x 3/4" screws.



Step 2

Position the engine on the mount. Adjust the engine so the distance from the firewall to the drive washer is 4 1/4". Use clamps to hold the engine in position.



Step 3

Mark the locations for the engine mounting bolts.

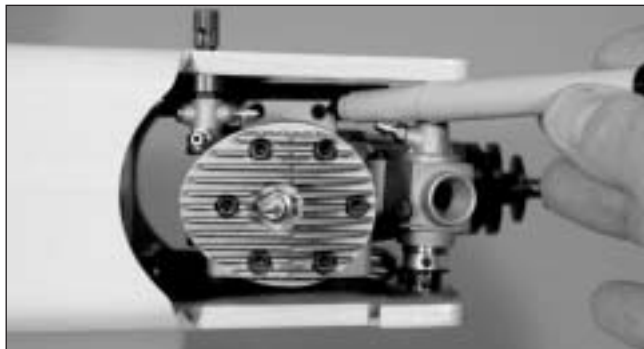

Step 4

Remove the engine and drill the locations marked in the previous step using a 9/64" drill bit.



Hint: Use a drill press for the best results. This makes holes perfectly perpendicular (square) to the mount.

Step 5

Attach the engine using four 3mm x 20mm socket head screws, four 3mm washers and four 3mm lock nuts.

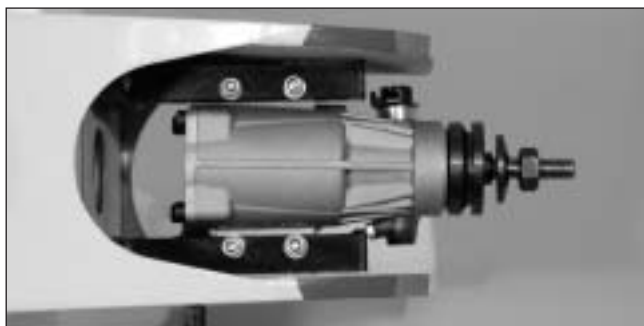

Section 8B: Electric Motor Installation

Required Parts

- Fuselage

Required Tools and Adhesives

- Electric motor (Hacker C50 10L recommended)
- Electronic speed control (Hacker master 70-3P)
- Heat shrink
- 8-32 lock nut (8)
- 8-32 x 12" threaded rod (2)
- 8-32 nut (4)
- #8 washer (12)
- Plywood (4" x 12" x 1/8")
- Electrical connectors
- Propeller (APC 16x12E)

There are numerous ways to convert your Twist™ to electric power. The following covers the installation of a Hacker power system using Li-Po batteries.

Step 1

Carefully measure and mark the centerline on the firewall using the measurements as shown.

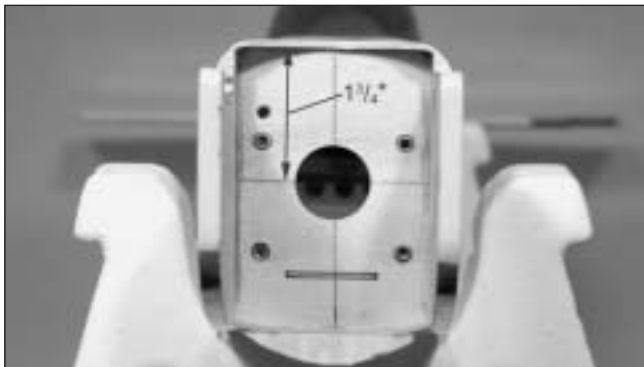

Step 2

Check the location of your particular motor. It may be necessary to remove material from the firewall to allow for motor clearance.

Step 3

Cut the 8-32 x 12" threaded rods so there are four pieces 4" in length.

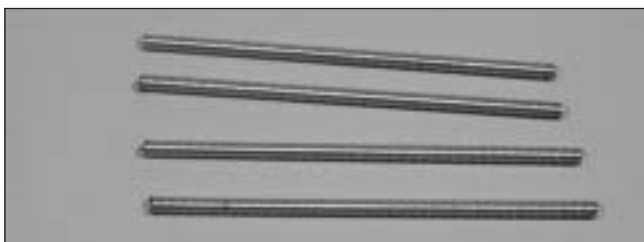

Hint: Place nuts onto the rod before cutting. Removing the nuts over the cut ends will clean the threads.

Step 4

Thread an 8-32 lock nut 3/8" onto one end of each threaded rod. Repeat for all four threaded rods.

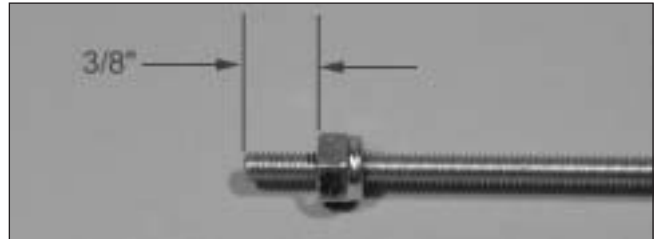

Step 5

Install the threaded rods into the firewall. Use #8 washers between the firewall and blind nuts. Tighten the nuts to prevent the rods from rotating.



Step 6

Construct a motor mount using plywood. The shape and style of the mount will vary depending on your motor and imagination. Make sure the mount is wide enough to fit tightly between the fuselage sides.

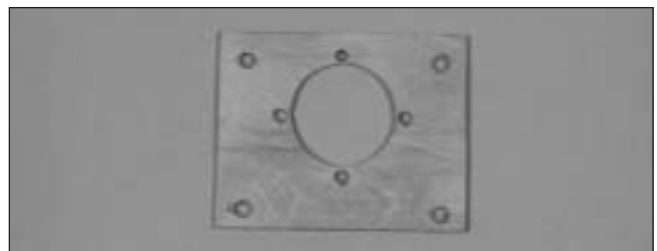

Step 7

Attach the motor to the motor mount plate.



Step 8

Thread an 8-32 nut and #8 washers onto each of the threaded rods. Slide the motor and mount onto the rods. Position the motor so the drive washer will be 4-1/4" forward of the firewall. Secure the plate using 8-32 lock nuts and #8 washers after making sure it is parallel to the firewall. Use 5-minute epoxy to glue the mount plate to the sides of the fuselage.

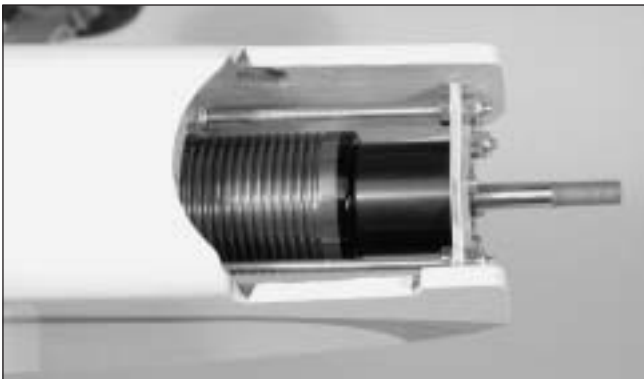

Step 9

Select a propeller appropriate for your motor system. Install the propeller and spinner as shown.



Step 10

Prepare your ESC for connection to the motor and motor battery following the instructions provided by the manufacturer. Remove the covering from the bottom of the fuselage and secure the ESC as shown.



Step 11

Mount the battery in the fuselage. It will be necessary to remove the throttle servo tray to fit the length of the battery. Make sure the battery can not shift during flight.



Section 9: Throttle Pushrod Installation

Required Parts

- Fuselage assembly
- 10¹/₈" outer pushrod tube
- 14⁵/₈" pushrod wire
- Clevis
- Clevis retainer

Required Tools and Adhesives

- Drill
- Drill bit: 5/32"
- Medium CA
- Sandpaper

Step 1

Determine the proper location for the throttle pushrod. Mark the location with a felt-tipped pen. Remove the engine and drill the firewall for the pushrod tube using a drill and 5/32" drill bit.



Step 2

Test fit the throttle pushrod tube through the firewall, through former 2, and into the fuselage. Once satisfied with the fit, roughen the tube using sandpaper. Slide the tube back into position and use medium CA to glue it to the firewall and former 2. Allow 1/4" of the pushrod to extend forward of the firewall.



Section 9: Throttle Pushrod Installation

Step 3

Slide a clevis retainer onto a nylon clevis. Thread a clevis onto a 14⁵/₈" wire, a minimum of 10 turns.



Step 4

Attach the clevis to the throttle arm on the carburetor. Slide the pushrod wire into the pushrod tube and re-install the engine. Bend the pushrod if necessary so it moves freely.

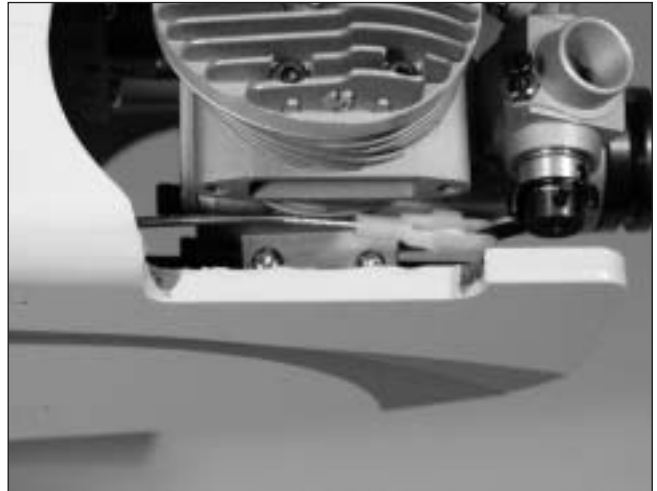

Section 10: Fuel Tank Assembly

Required Parts

- Clunk (fuel pickup)
- Fuel pickup tubing
- Rubber stopper
- Metal tube (2)
- Metal caps (2)
- Fuel tank
- M3 x 20 screw

Required Tools and Adhesives

- Hobby knife
- Phillips screwdriver (small)

Note: The stopper provided with the Twist™ has three holes that are not bored completely through the stopper. The holes are for the fuel pickup, fill and vent lines. For these instructions, only two holes will be used: one for the fuel pickup and one for the fuel vent. *Only open the third hole if you are going to use a separate fill line.*

Step 1

Locate the fuel tank parts.

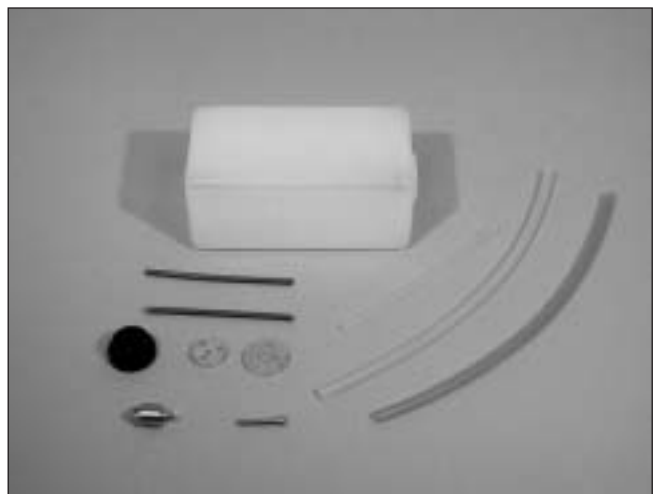

Section 10: Fuel Tank Assembly

Step 2

Locate the rubber stopper. Insert one of the metal fuel tubes into one of the holes in the stopper so that an equal amount of tube extends from each side of the stopper. This tube will be the fuel tank pickup that provides fuel to the engine.



Step 3

Slide the smaller cap over the tube on the smaller end of the rubber stopper. This end will be inserted into the fuel tank. The larger cap is placed on the side of the rubber stopper that makes the cap. Loosely install the M3 x 20 screw through the center of the stopper.



Step 4

Bend the remaining fuel tube carefully to a 45-degree angle using your fingers. This will be the fuel tank vent tube.

Use care not to kink the tube while bending.



Step 5

Slide the vent tube into one of the remaining two holes in the stopper from the tank (small cap) side.



Section 10: Fuel Tank Assembly

□ Step 6

Locate the short piece of silicone fuel tubing and the fuel tank clunk. Install the clunk onto one end of the silicone tubing. Slide the silicone tubing (end opposite the clunk) onto the fuel tank pickup tube (straight tube) in the stopper.

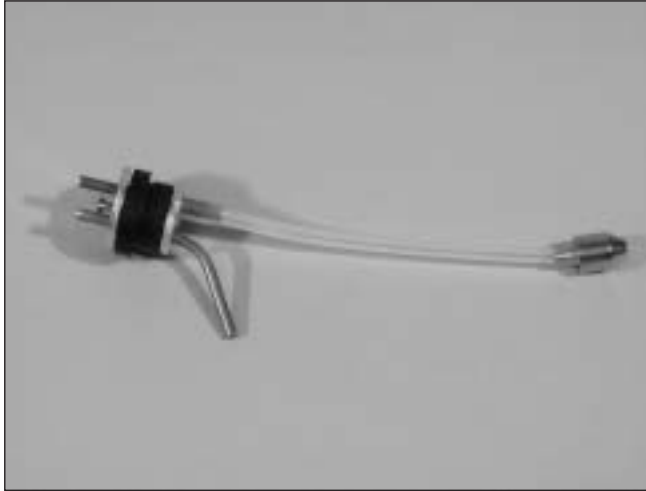

□ Step 7

Carefully insert the stopper assembly into the fuel tank. Note the position of the vent tube; it must be up at the top portion of the fuel tank to function properly. (Hint: The fuel tank is taller than it is wide.) Also, it may be necessary to shorten the length of the fuel pickup tubing to make sure the clunk does not rub against the back of the fuel tank. You should be able to turn the tank to any attitude and have the clunk fall to the lowest point (all directions, except for having the stopper facing down).

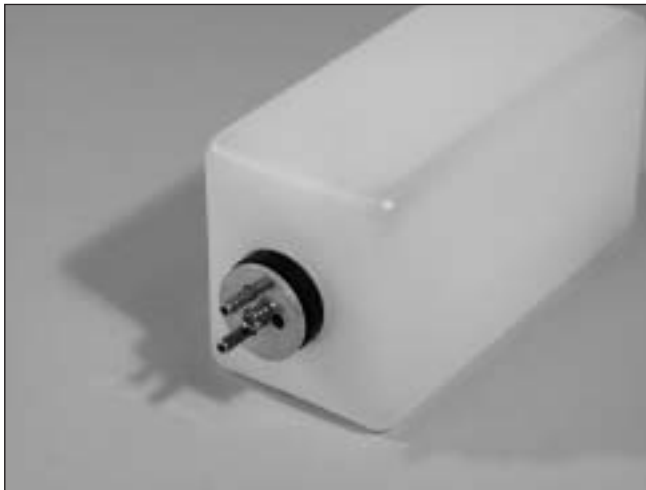

□ Step 8

Tighten the M3 x 20 screw carefully—do not over tighten. This allows the rubber stopper to form a seal by being slightly compressed, thus sealing the fuel tank opening.

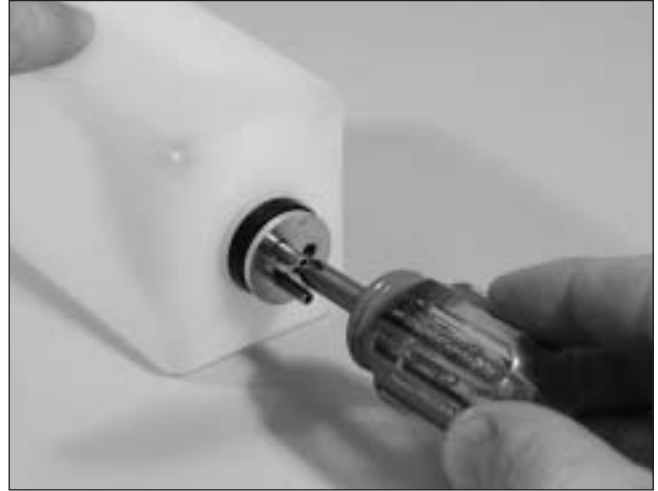

Important: Be sure to differentiate between the vent and fuel pickup tube. Once the tank is mounted inside the fuselage, it will be difficult to tell the tubes apart.

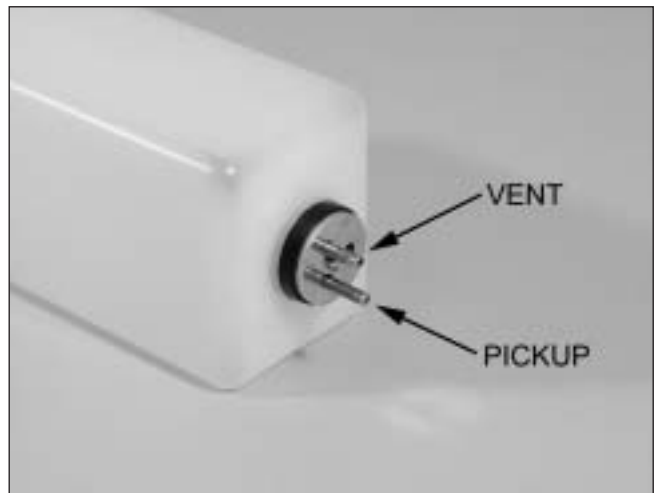

Section 11: Fuel Tank Installation

Required Parts

- Fuselage assembly
- Fuel tank assembly
- Fuel tubing (red and green)

Required Tools and Adhesives

- Foam: 1/2"

Step 1

Glue a piece of 1/2" foam to the sides of the fuel tank compartment. Glue two pieces of 1/2" foam to the upper inside of the fuel tank compartment so there will be 1" of foam between the upper inside of the fuselage and the fuel tank.



Step 2

Connect the two pieces of fuel tubing to the fuel tanks pickup and vent tubes.

Hint: Connect the red tube to the vent, and the green tube to the pickup. If you forget, just come back to this paragraph to remind yourself.

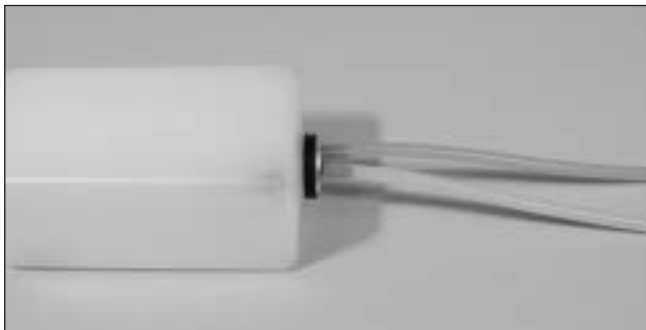

Step 3

Install the fuel tank into the fuselage. Make any necessary supports to keep the tank from moving during flight.

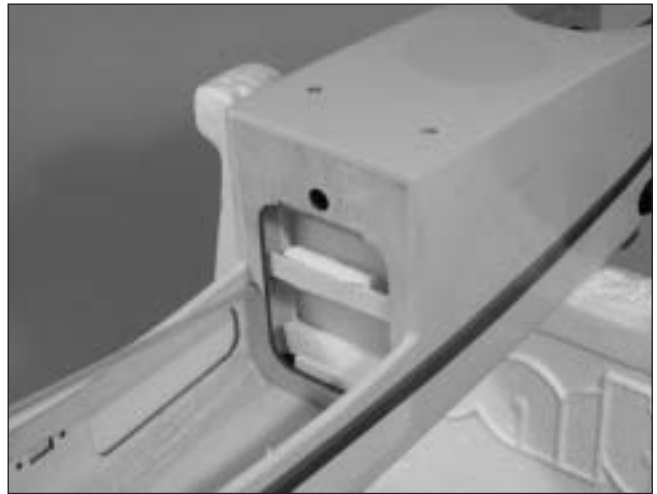

Hint: Make sure the rear support brace will not interfere with the installation of the wing.

Step 4

Attach the muffler to the engine. Make the proper connections to the engine using the engine manufacturer's instructions.

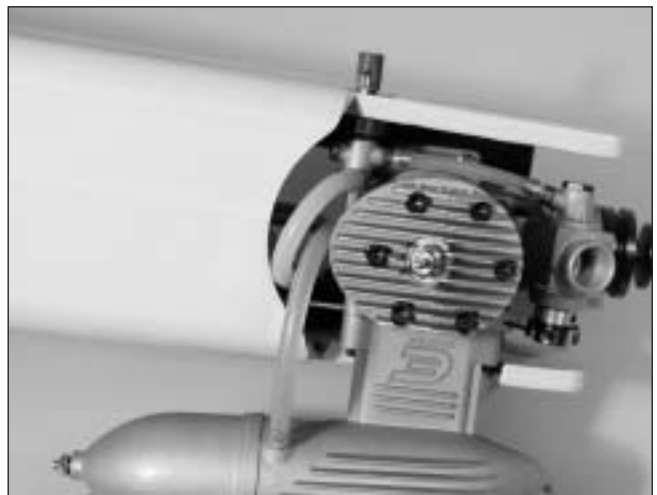

Section 12: Landing Gear Installation

Required Parts

- Fuselage assembly
- 2³/₄" wheel (2)
- 5/32" x 1" axle w/nut (2)
- 1" wheel
- 5/32" wheel collar (2)
- Landing gear
- 8-32 x 1/2" screw (2)
- 3mm x 5mm screw (2)
- 1/16" wheel collar w/set screw

Required Tools and Adhesives

- Drill
- Drill bits: 1/16", 1/8", 5/32"
- Phillips screwdriver (large)
- Hex wrench (included in kit)

Step 1

Locate the main landing gear and two 8-32 x 1/2" screws. Attach the main landing gear using the screws. The angle on the gear should be towards the rear of the plane.

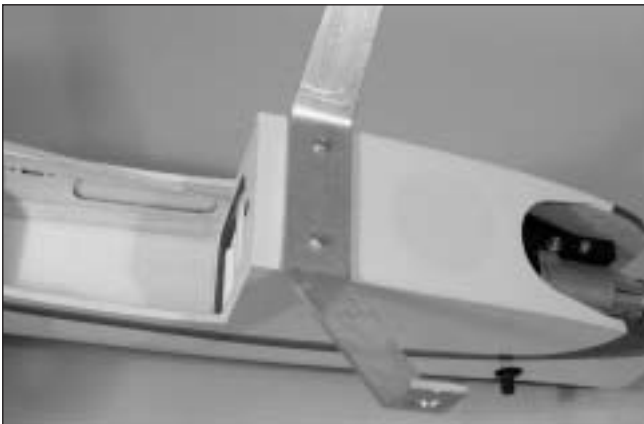

Step 2

Attach an axle to the landing gear using the supplied nut.



Step 3

Attach the wheel to the axle using a wheel collar and 3mm x 5mm screw.



Hint: File a flat area where the screw contacts the axle, to help prevent the screw from loosening during flight.

Step 4

Repeat Steps 2 and 3 for the remaining wheel.

Step 5

Attach the tail wheel using a 5/32" wheel collar.



Section 13: Radio Installation

Required Parts

- Fuselage assembly
- Wing assembly
- Servo w/hardware (5)

Required Tools and Adhesives

- Drill
- Drill bit: 1/16"
- Phillips screwdriver (small)
- Servo extension – 12" (2)

Step 1

Install the recommended servo hardware (grommets and eyelets) supplied with your radio system onto five servos (elevator, rudder, throttle, and aileron (2)).

Step 2

Temporarily install the rudder servo.

Step 3

Mark the locations for the servo screws using a felt-tipped pen.



Step 4

Remove the servo and drill the holes for the servo mounting screws using a 1/16" drill bit.



Hint: Place a drop of thin CA onto each screw hole to harden the wood around the hole. Allow the CA to fully cure before installing the servos.

Step 5

Attach a 12" servo extension onto the rudder servo. Use your favorite method to secure the extension to prevent it from coming loose during flight. Secure the rudder servo using the screws provided with the servo.



Step 6

Repeat Steps 1 through 5 for the elevator servo.

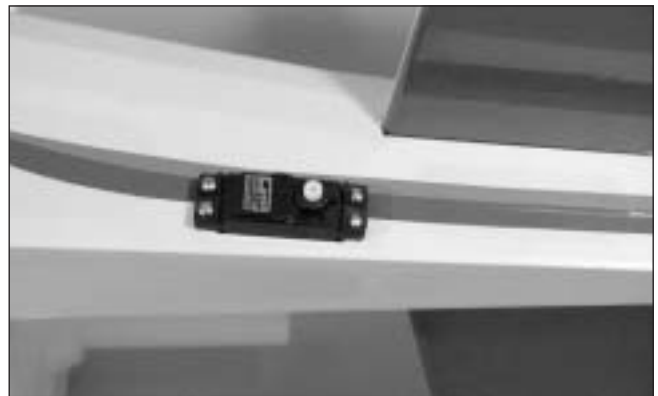

Section 13: Radio Installation

Step 7

Temporarily install the aileron servo and mark the locations for the servo screws using a felt-tipped pen.

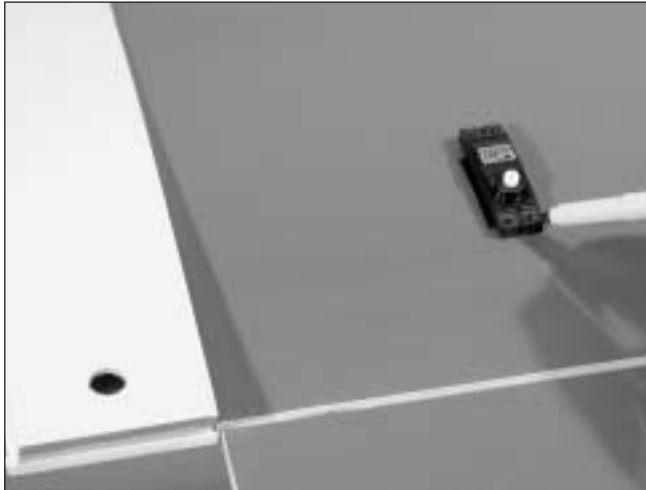

Step 8

Remove the servos and drill the holes for the servo mounting screws using a 1/16" drill bit.

Step 9

Use a piece of string with a small weight (such as a wheel collar) attached as a device to pull the servo lead through the wing. Lower the weight through the servo opening, allowing it to pass through the ribs and out the hole in the center of the wing.

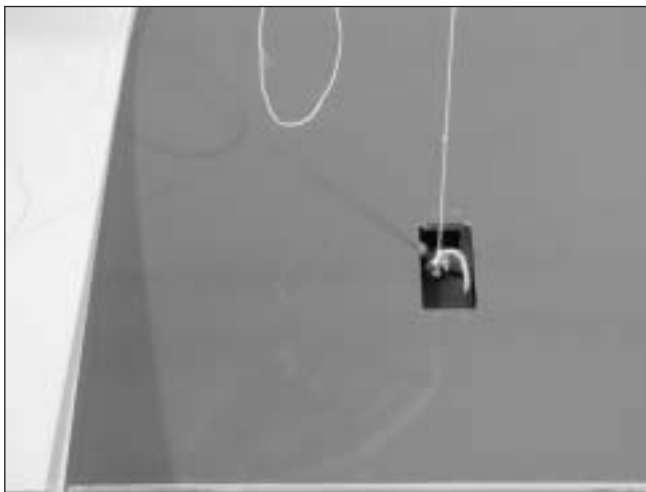
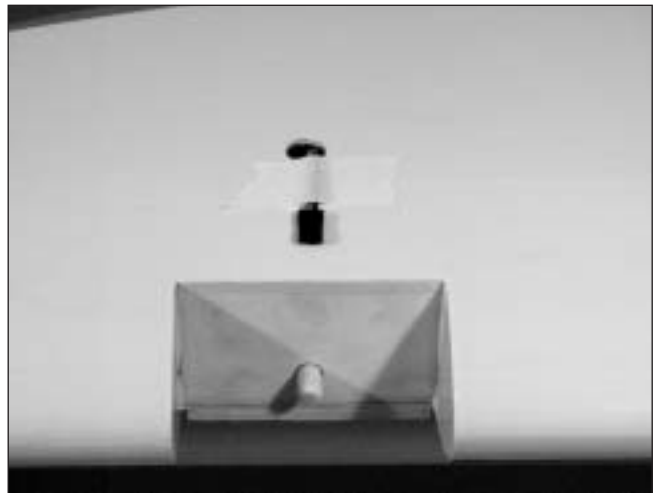

Photo for Step 9



Step 10

Tie the string onto the servo extension. Gently pull the extension through the wing using the string. Untie the string when the servo lead has been pulled through. Use tape to secure the servo lead to the wing to prevent it from falling back into the wing panel. Secure the aileron servo using the hardware provided with the servo.



Step 11

Repeat Steps 7 through 10 for the other aileron servo.

Section 13: Radio Installation

Step 12

Secure the throttle servo using the screws supplied with the servo.



Step 13

Wrap the receiver and receiver battery in protective foam to prevent damage that may be caused by engine vibration.

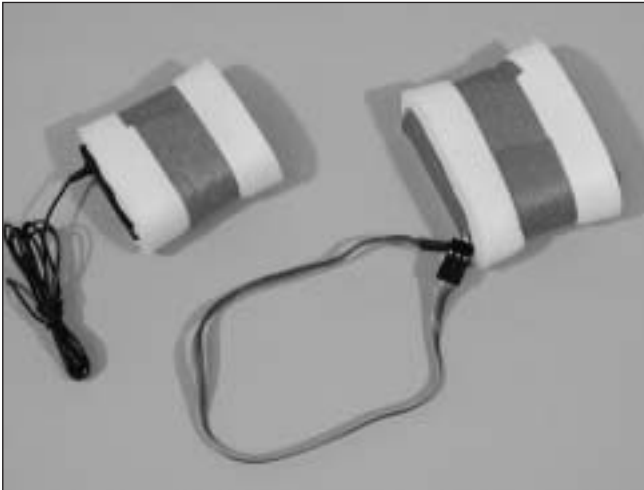

Step 14

Temporarily mount the receiver and battery into the fuselage. It may be necessary to relocate the battery forward or aft to balance the model as described in the section "Control Throws and Center of Gravity." Plug in any servo leads or extensions at this time and connect any extensions necessary for the aileron servos.



Step 15

Route the antenna out through the tube in the fuselage.

Step 16

Mount the radio switch in the side of the fuselage opposite the throttle linkage.

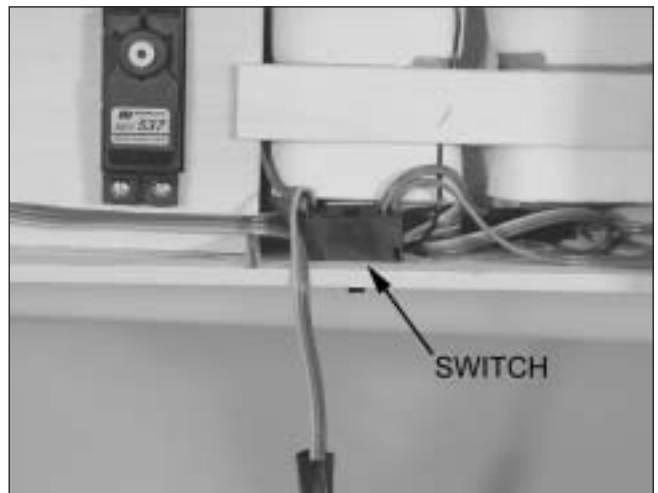

Section 14: Linkage Installation

Required Parts

- Fuselage assembly
- Wing assembly
- 4³/₈" pushrod wire (2)
- Nylon clevis (4)
- 10⁵/₈" pushrod wire (2)
- Clevis retainer (4)
- Nylon wire keeper (5)
- Nylon control horn (4)
- 2-56 x 1/2" screw (12)

Required Tools and Adhesives

- Drill bits: 1/16", 3/32"
- Drill
- Phillips screwdriver (small)

Step 1

Slide a clevis retainer onto a nylon clevis. Thread a clevis onto a 10⁵/₈" wire, a minimum of 10 turns.



Step 2

Remove the back plate from a control horn using side cutters or a sharp hobby knife.

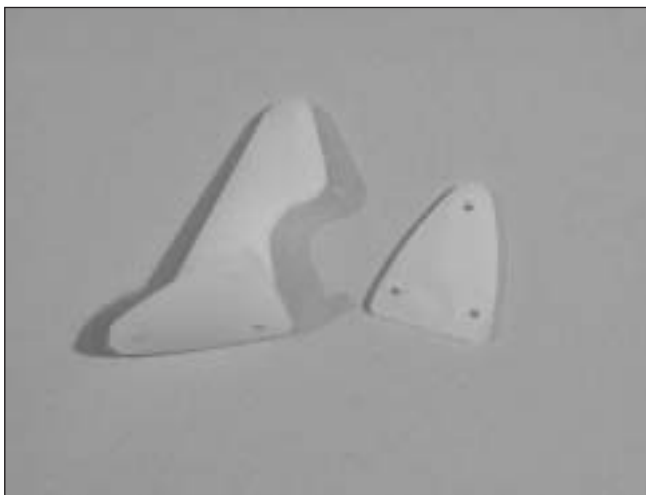

Step 3

Position the control horn on the elevator so the horn aligns with the hinge line of the elevator. Mark the position for the mounting holes using a felt-tipped pen.

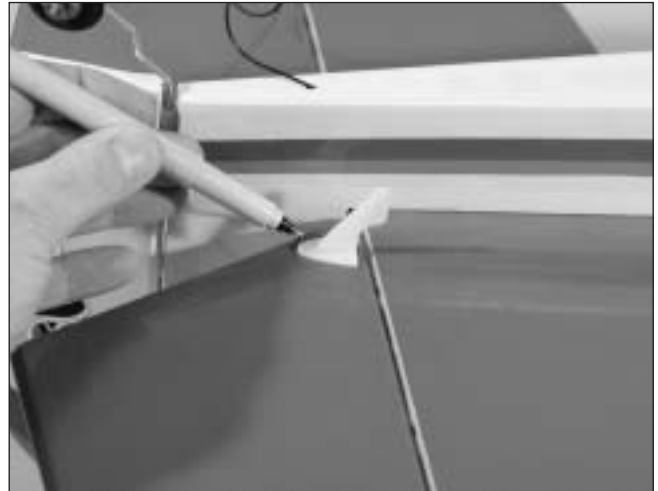

Step 4

Drill three 3/32" holes through the elevator at the locations marked in the previous step.

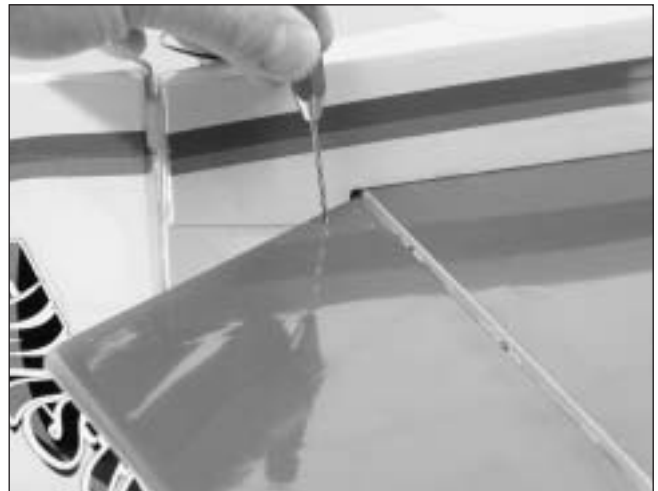

Section 14: Linkage Installation

□ □ Step 5

Place 2–3 drops of thin CA into the hole to harden the wood. Repeat this for each of the three holes.



□ □ Step 6

Attach the control horn using three 2-56 x 1/2" screws and the control back plate.

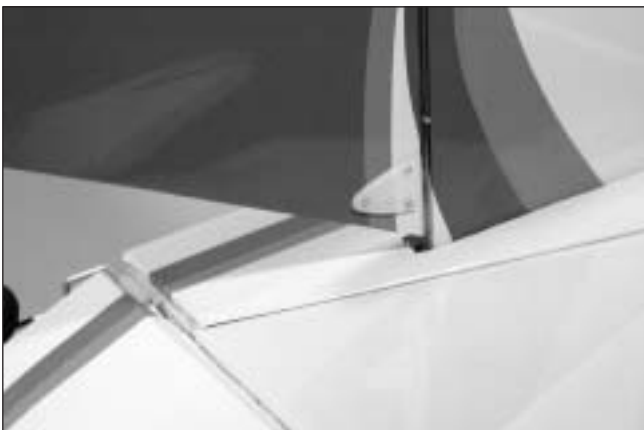

□ □ Step 7

Center the elevator servo electronically using the radio system. Install a servo arm onto the elevator servo. Attach the pushrod with clevis to the control horn. Physically place the elevator control surface in neutral. Mark the pushrod where it crosses the holes in the servo arm.



□ □ Step 8

Bend the wire 90-degrees at the mark made in the previous step



Section 14: Linkage Installation

Step 9

Cut the wire 3/8" above the bend.

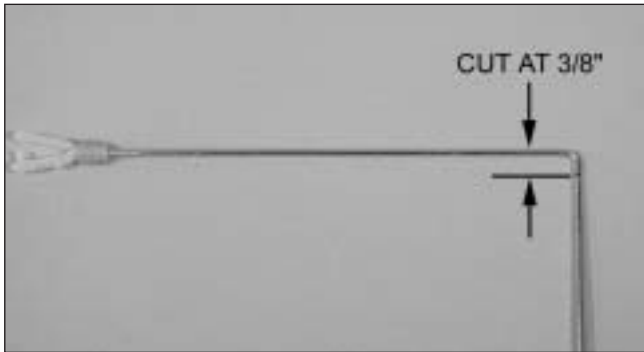

Step 10

Slide the wire through the hole one in from the end of the elevator servo arm. Secure the wire using a nylon wire keeper.



Step 11

Repeat Steps 1 through 10 for the rudder linkage.

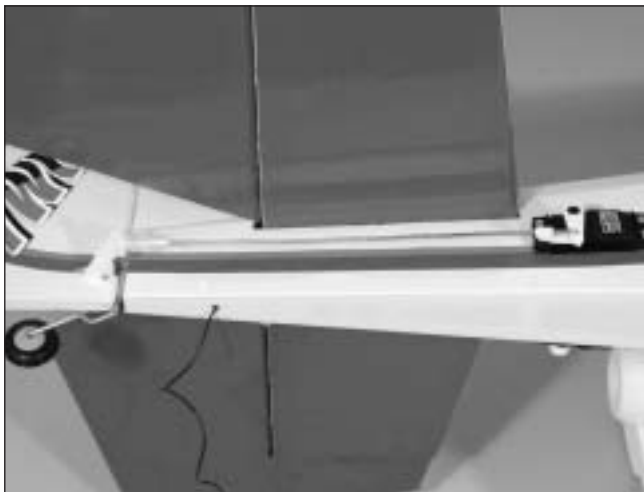

Step 12

Slide a clevis retainer onto a nylon clevis. Thread a clevis onto a 4 3/8" wire a minimum of 10 turns.

Step 13

Remove the back plate from a control horn using side cutters or a sharp hobby knife.

Step 14

Position the control horn on the aileron so the horn aligns with the hinge line of the aileron. Mark the position for the mounting holes using a felt-tipped pen.

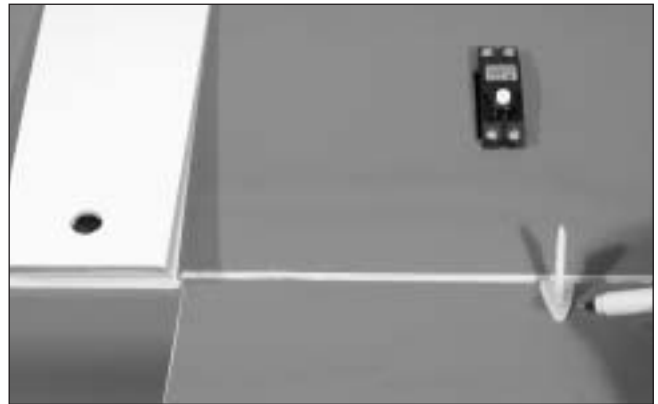

Step 15

Drill three 3/32" holes at the locations marked in the previous step.

Step 16

Place 2-3 drops of thin CA into the hole to harden the wood. Repeat this for each of the three holes.

Step 17

Attach the control horn using three 2-56 x 1/2" screws and the control back plate.

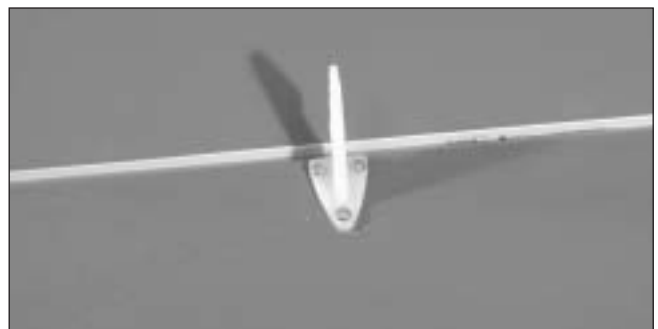

Section 14: Linkage Installation

Step 18

Center the aileron servo electronically using the radio system. Install a servo arm onto the aileron servo. Attach the pushrod with clevis to the control horn. Physically place the aileron control surface in neutral. Mark the pushrod where it crosses the holes in the servo arm.

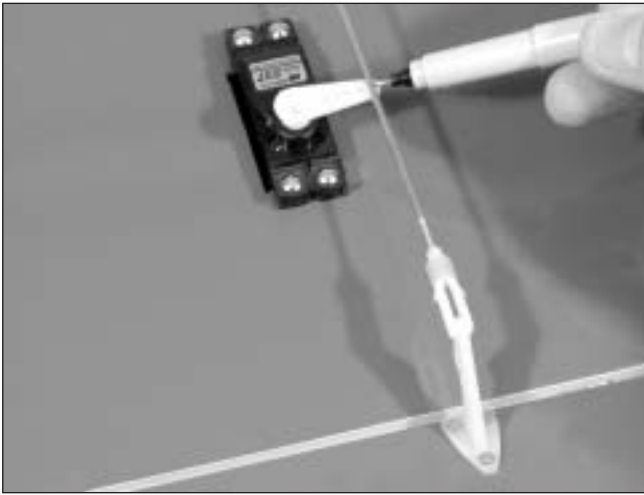

Step 19

Bend the wire 90-degrees at the mark made in the previous step. Cut the wire 3/8" above the bend.

Step 20

Slide the wire through the outer hole in the aileron servo arm. Secure the wire using a nylon wire keeper.

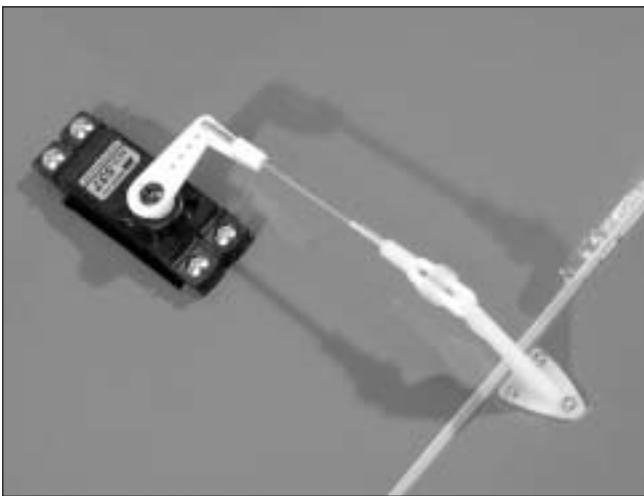

Step 21

Repeat Steps 12 through 20 for the other aileron servo.

Step 22

Center the throttle stick and trim with both the receiver and transmitter on. Install the throttle servo arm in the neutral position.

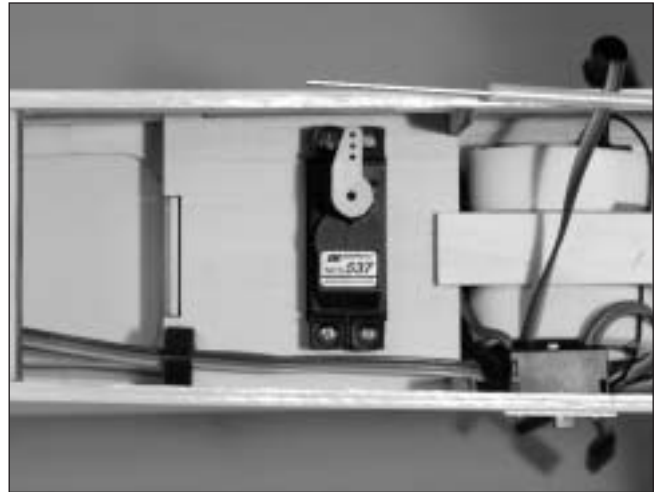

Step 23

Move the servo to the throttle closed position using the radio system. Manually move the throttle arm to the closed position. Mark the location where the pushrod crosses the servo arm using a felt-tipped pen.

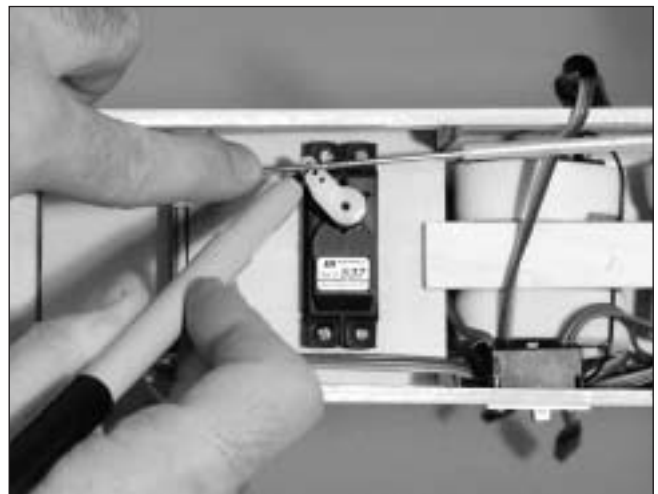

Section 14: Linkage Installation

Step 24

Make a 90-degree bend at the mark made in the last step. Temporarily connect the pushrod to the throttle arm. Check the movement of the throttle to verify there is no binding at either low or high throttle. If there is, make the necessary adjustment to eliminate any binding.



Step 25

Secure the throttle pushrod to the servo arm using a nylon wire keeper. Install the throttle servo arm screw when complete.



Section 15: Canopy Installation

Required Parts

- Fuselage assembly
- Canopy

Required Tools and Adhesives

- Canopy glue (RC-56)
- Sandpaper (medium grit)

Step 1

Install a pilot of your choosing. Use epoxy or Zap-A-Dap-A-Goo to secure the pilot.

Step 2

Position the canopy onto the fuselage so the front edge of the canopy is $3\frac{7}{8}$ " forward of the instrument panel. Draw a line around the canopy using a felt-tipped pen so $3\frac{7}{8}$ " of the canopy will overlap onto the fuselage.

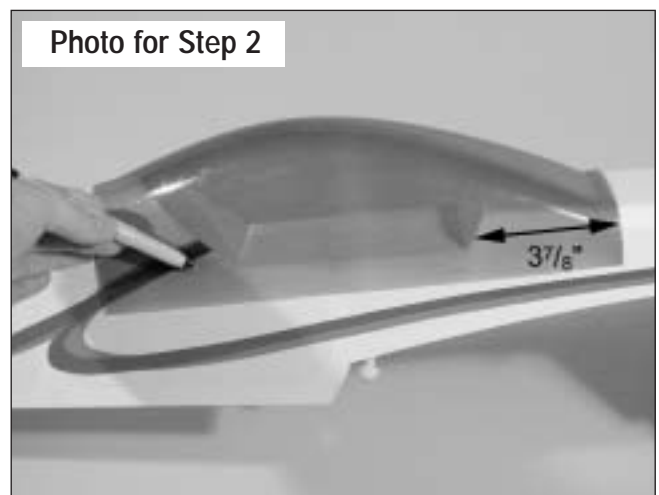

Section 15: Canopy Installation

Step 3

Use a hobby knife and scissors to trim the canopy along the lines drawn in the previous step.

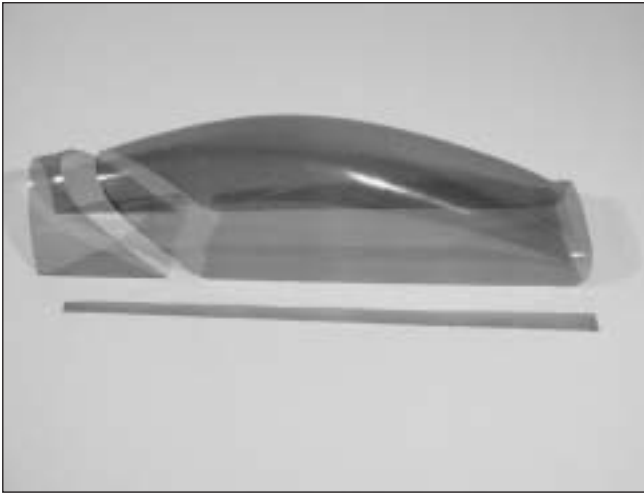

Step 4

Position the canopy back onto the fuselage. Trace around the canopy and onto the fuselage using a felt-tipped pen.



Step 5

Lightly sand the inside edge of the canopy and slightly inside the line drawn on the hatch using medium sandpaper.

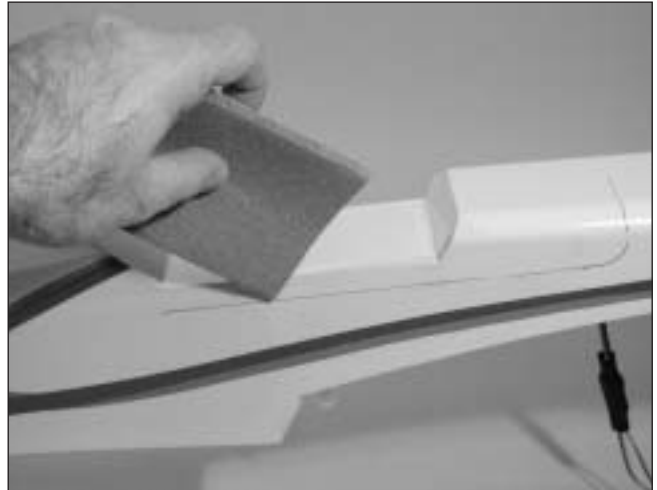

Step 6

Apply a bead of RCZ56 Canopy Glue (ZINJ5007) around the inside edge of the canopy. Position the canopy onto the hatch. Use tape to hold it secure until the glue fully cures.

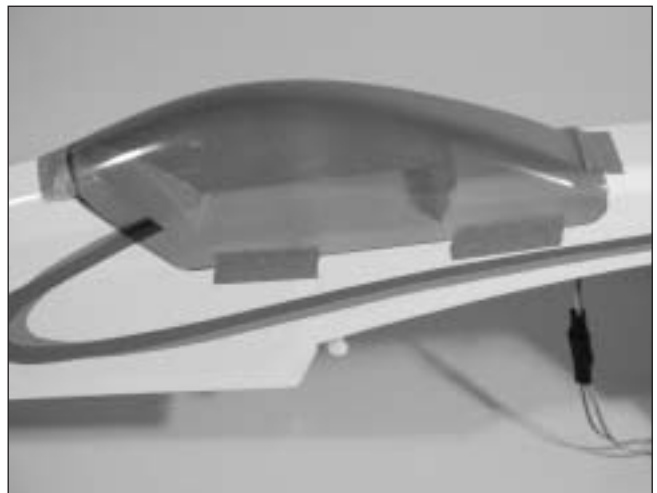

Adjusting the Engine

□ Step 1

Completely read the instructions included with your engine and follow the recommended break-in procedure.

□ Step 2

At the field, adjust the engine to a slightly rich setting at full throttle and adjust the idle and low-speed needle so that a consistent idle is achieved.

□ Step 3

Before you fly, be sure that your engine idles reliably, transitions and runs at all throttle settings. Only when this is achieved should any plane be considered ready for flight.

Control Throws

The amount of control throw should be adjusted as closely as possible using mechanical means, rather than making large changes electronically at the radio. By moving the position of the clevis at the control horn toward the outermost hole, you will decrease the amount of control throw of the control surface. Moving it toward the control surface will increase the amount of throw. Moving the pushrod wire at the servo arm will have the opposite effect: Moving it closer to center will decrease throw, and away from center will increase throw. Work with a combination of the two to achieve the closest or exact control throws listed.

Note: Aircraft is being tested. The correct throws and center of gravity will be added during layout.

| | Low Rate | High Rate |
|----------|---|--|
| Aileron | 1" (15°) up | 1 ⁵ / ₈ " (23°) up |
| | 1" (15°) down | 1 ⁵ / ₈ " (23°) down |
| Elevator | 1" (14°) up | 2" (25°) up |
| | 1" (14°) down | 2" (25°) down |
| Rudder | 1 ³ / ₄ " (18°) left | 2" (22°) left |
| | 1 ³ / ₄ " (18°) right | 2" (22°) right |

Note: Control throws are measured at the widest part of the elevator, rudder, and aileron unless noted otherwise.

Use the following throws for 3D aerobatics:

| | | |
|----------|---|--|
| Aileron | 2 ¹ / ₂ " (35°) up | 2 ¹ / ₂ " (35°) down |
| Elevator | 2 ³ / ₄ " (35°) up | 2 ³ / ₄ " (35°) down |
| Rudder | 2 ¹ / ₂ " (28°) right | 2 ¹ / ₂ " (28°) left |

Recommended CG

An important part of preparing the aircraft for flight is properly balancing the model. This is especially important when various engines are mounted.

Caution: Do not inadvertently skip this step!

The recommended Center of Gravity (CG) range for the Twist™ is 4"–5" behind the leading edge of the wing against the fuselage. It is suggested to start at the forward end of the range until comfortable with the flight characteristics of your aircraft. If necessary, move the battery pack or add weight to either the nose or the tail until the correct balance is achieved. Stick-on weights are available at your local hobby shop and work well for this purpose.

Preflight

Charge both the transmitter and receiver pack for your airplane. Use the recommended charger supplied with your particular radio system, following the instructions provided with the radio. In most cases the radio should be charged the night before going out flying.

Check the radio installation and make sure all the control surfaces are moving correctly (i.e. the correct

direction and with the recommended throws). Test-run the engine and make sure it transitions smoothly from idle to full throttle and back. Also ensure the engine is tuned according to the manufacturer's instructions, and it will run consistently and constantly at full throttle when adjusted.

Check all the control horns, servo horns and clevises to make sure they are secure and in good condition. Replace any items that would be considered questionable. Failure of any of these components in flight would mean the loss of your aircraft.

Range Testing the Radio

Before each flying session, range-check your radio. This is accomplished by turning on your transmitter with the antenna collapsed. Turn on the radio in your airplane. With your airplane on the ground, you

should be able to walk 30 paces away from your airplane and still have complete control of all functions. If not, don't attempt to fly! Have your radio equipment checked out by the manufacturer.

2004 Official AMA National Model Aircraft Safety Code

GENERAL

- 1) I will not fly my model aircraft in sanctioned events, air shows or model flying demonstrations until it has been proven to be airworthy by having been previously, successfully flight tested.
- 2) I will not fly my model higher than approximately 400 feet within 3 miles of an airport without notifying the airport operator. I will give right-of-way and avoid flying in the proximity of full-scale aircraft. Where necessary, an observer shall be utilized to supervise flying to avoid having models fly in the proximity of full-scale aircraft.
- 3) Where established, I will abide by the safety rules for the flying site I use, and I will not willfully and deliberately fly my models in a careless, reckless and/or dangerous manner.
- 4) The maximum takeoff weight of a model is 55 pounds, except models flown under Experimental Aircraft rules.
- 5) I will not fly my model unless it is identified with my name and address or AMA number, on or in the model. (This does not apply to models while being flown indoors.)
- 6) I will not operate models with metal-bladed propellers or with gaseous boosts, in which gases other than air enter their internal combustion engine(s); nor will I operate models with extremely hazardous fuels such as those containing tetranitromethane or hydrazine.

- 7) I will not operate models with pyrotechnics (any device that explodes, burns, or propels a projectile of any kind) including, but not limited to, rockets, explosive bombs dropped from models, smoke bombs, all explosive gases (such as hydrogen-filled balloons), ground mounted devices launching a projectile. The only exceptions permitted are rockets flown in accordance with the National Model Rocketry Safety Code or those permanently attached (as per JATO use); also those items authorized for Air Show Team use as defined by AST Advisory Committee (document available from AMA HQ). In any case, models using rocket motors as a primary means of propulsion are limited to a maximum weight of 3.3 pounds and a G series motor. (A model aircraft is defined as an aircraft with or without engine, not able to carry a human being.)
- 8) I will not consume alcoholic beverages prior to, nor during, participation in any model operations.
- 9) Children under 6 years old are only allowed on the flight line as a pilot or while under flight instruction.

RADIO CONTROL

- 1) I will have completed a successful radio equipment ground range check before the first flight of a new or repaired model.
- 2) I will not fly my model aircraft in the presence of spectators until I become a qualified flier, unless assisted by an experienced helper.
- 3) At all flying sites a straight or curved line(s) must be established in front of which all flying takes place with the other side for spectators. Only personnel involved with flying the aircraft are allowed at or in the front of the flight line. Intentional flying behind the flight line is prohibited.
- 4) I will operate my model using only radio control frequencies currently allowed by the Federal Communications Commission. (Only properly licensed Amateurs are authorized to operate

2004 Official AMA National Model Aircraft Safety Code

equipment on Amateur Band frequencies.)

5) Flying sites separated by three miles or more are considered safe from site-to site interference, even when both sites use the same frequencies. Any circumstances under three miles separation require a frequency management arrangement, which may be either an allocation of specific frequencies for each site or testing to determine that freedom from interference exists. Allocation plans or interference test reports shall be signed by the parties involved and provided to AMA Headquarters. Documents of agreement and reports may exist between (1) two or more AMA Chartered Clubs, (2) AMA clubs and individual AMA members not associated with AMA Clubs, or (3) two or more individual AMA members.

6) For Combat, distance between combat engagement line and spectator line will be 500 feet per cubic inch of engine displacement. (Example: .40 engine = 200 feet.); electric motors will be based on equivalent combustion engine size. Additional safety requirements will be per the RC Combat section of the current Competition Regulations.

7) At air shows or model flying demonstrations, a single straight line must be established, one side of which is for flying, with the other side for spectators.

8) With the exception of events flown under AMA Competition rules, after launch, except for pilots or helpers being used, no powered model may be flown closer than 25 feet to any person.

9) Under no circumstances may a pilot or other person touch a powered model in flight.

Organized RC Racing Event

10) An RC racing event, whether or not an AMA Rule Book event, is one in which model aircraft compete in flight over a prescribed course with the objective of finishing the course faster to determine the winner.

A. In every organized racing event in which contestants, callers and officials are on the course:

1. All officials, callers and contestants must properly wear helmets, which are OSHA, DOT, ANSI, SNELL or NOCSAE approved or comparable standard while on the racecourse.

2. All officials will be off the course except for the starter and their assistant.

3. "On the course" is defined to mean any area beyond the pilot/staging area where actual flying takes place.

B. I will not fly my model aircraft in any organized racing event which does not comply with paragraph A above or which allows models over 20 pounds unless that competition event is AMA sanctioned.

C. Distance from the pylon to the nearest spectator (line) will be in accordance with the current Competition Regulations under the RC Pylon Racing section for the specific event pending two or three pylon course layout.

11) RC night flying is limited to low-performance models (less than 100 mph). The models must be equipped with a lighting system that clearly defines the aircraft's attitude at all times.



© 2004, Horizon Hobby, Inc.
4105 Fieldstone Road
Champaign, Illinois 61822
(877) 504-0233
www.horizonhobby.com